

T-Grid Linear Solution

Our revolutionary approach to create this lighting fixture with one simple concept in mind: how to break the monotonous traditional horizontal layout forms then enriched space level and how to help customer save cost?

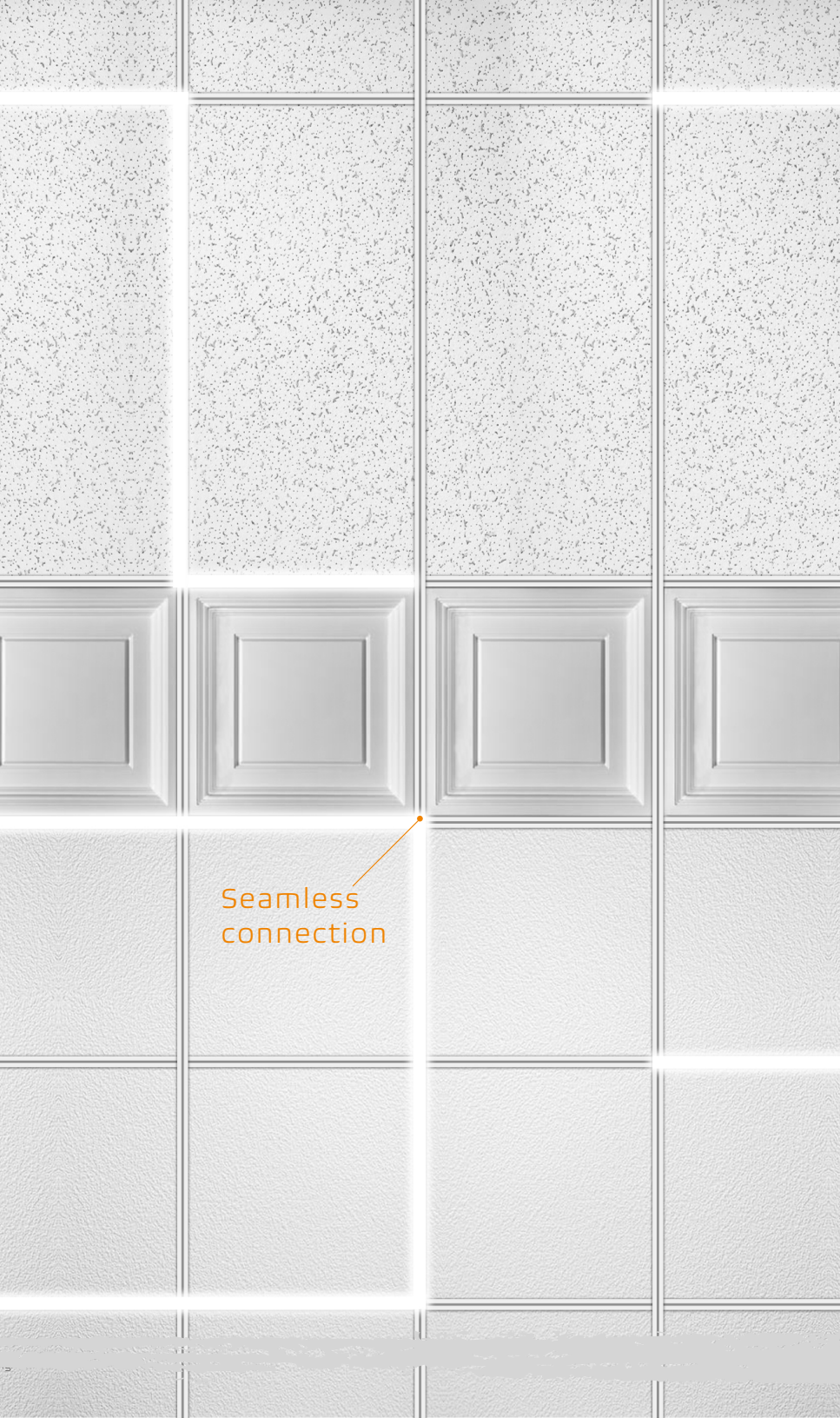

Seamless
connection



We Believe in Simplicity = Beauty

Under a suspended ceiling construction, imagine a simple grid lighting system can save labor cost and reduce the building waste, but also show the characteristics of your commercial space. Let the ceiling tile shine with integrated lighting, we made it easy for you to specify and maintain the crisp. TB series is compatible with known industry's standard size ceiling tiles, whether it's 9/16" or 15/16".



Speed

It can be parallel connected up to 3pcs fixtures per power supply.



Flexibility

It is free to create compelling spaces, your space no longer has to be restricted to a single pattern on the ceiling.



Reduced Cost

Simply wiring and RJ45 terminal make easy installation and safe wiring.



Simplicity

0.48" thickness, almost integrated to T-grid ceiling.



Precise Optics

Available in 4 professional distributions. The TB series is certain to meet the most stringent of application requirements. This innovative produce design brings both performance and aesthetics to any design applications.

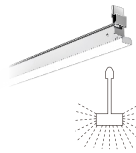

Milky Diffuser
 9/16" Flat, 9/16" Interlude,
 9/16" Slot and 15/16" Flat
 120° Beam Angle



Micro Reflector
 15/16"
 85° Beam Angle



Clear Lens
 15/16"
 70° or 90° Beam Angle

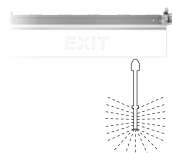

Signage
 9/16"
 110° Beam Angle





Universal Compatibility

It is a new generation green lighting solution that integrated into T-Grid suspended ceilings, allowing to be fully and seamlessly integrated into 9/16" flat, 9/16" slot 9/16" interlude or 15/16" flat T-grid. It can replace selected cross tees of the suspended grid ceiling system where light is desired.



T-Grids Ceiling Compatibility

9/16" Flat



9/16" Interlude

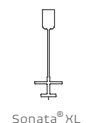
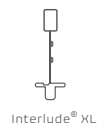

9/16" Slot

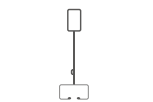
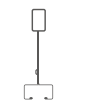

15/16" Flat

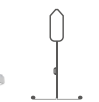
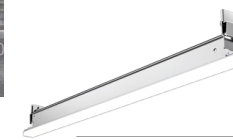

Note: Suprafine®, Silhouette®, Interlude®, Sonata®, Prelude®, are trademarks of Armstrong World Industries (AWI) company.

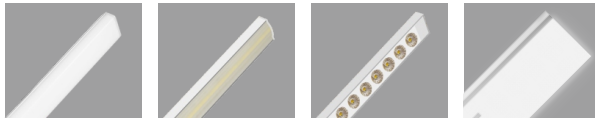
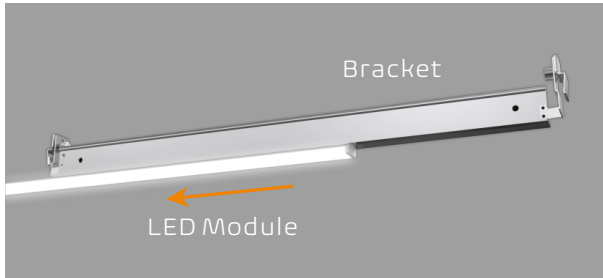

Milky Diffuser

Clear Lens

Micro Reflector

Signage

Replace the LED module

Lower your inventory risk and reduce costs.

The innovative separable design of led module and T-Grid bracket makes it more flexible. One T-grid bracket allows for seamless integration of multiple led modules with different CCT or types with easy and tool-free installation.



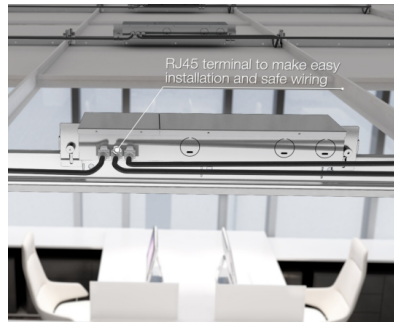
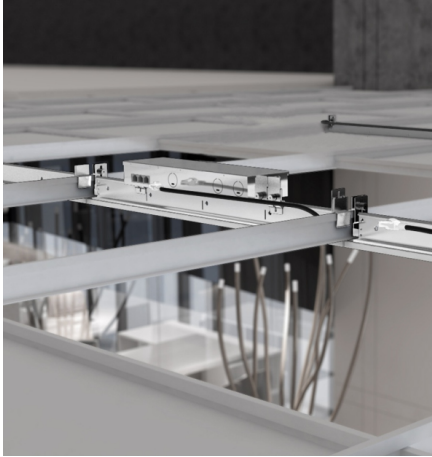

Easy Wiring And Mess Free

Smart mounting brackets with remote drivers

It can be parallel connected up to 6ft (2' fixture) and 12ft (4' fixture) max per power supply. Max distance from fixtures to power supply is 8 feet with 24 AWG cable. RJ45 terminal make easy installation and safe wiring.



Architect - Friendly

Flexible Lighting Solutions

T-Grid LED can be installed in many configurations by replacing any of the cross tees between the main runners of the suspended grid ceiling system assembly, providing a flexible general lighting solution for commercial and institutional environments such as offices, classrooms, retail and public space.

Custom Configuration

Considering different dimension and functions of a room, it is free to create compelling spaces, and your space no longer has to be restricted to a single pattern on the ceiling. Custom pattern such as L, T, +, □ etc.

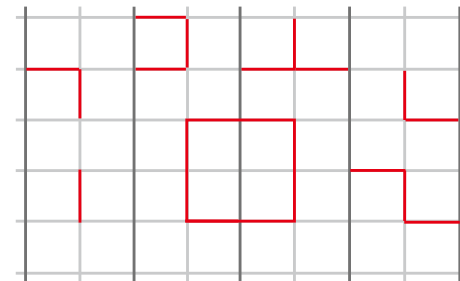







- Examples of configurations
- Possible positions for T-grid LED light modules
- One-piece main runner cannot be replaced

Seamless Continuous Runs



No gap, create linear lighting atmosphere.



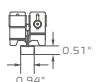
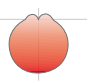
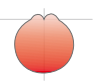
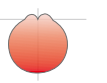
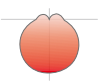

Milky Diffuser

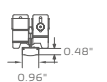
| | | | |
|---|---|---|---|
|  |  |  |  |
| 9/16\" | 9/16\" | 9/16\" | 15/16\" |
| Flat | Slot | Interlude | Flat |
| Dimension | Dimension | Dimension | Dimension |
|  |  |  |  |
| Length & Wattage | Length & Wattage | Length & Wattage | Length & Wattage |
| 2' 10W 4' 20W | 2' 10W 4' 20W | 2' 10W 4' 20W | 2' 10W 4' 20W |
| Efficacy | Efficacy | Efficacy | Efficacy |
| 575 LM/FT | 575 LM/FT | 575 LM/FT | 650 LM/FT |
| Custom Pattern | Custom Pattern | Custom Pattern | Custom Pattern |
| Yes | Yes | / | Yes |
| Beam Angle | Beam Angle | Beam Angle | Beam Angle |
| 128° | 128° | 128° | 123° |
|  |  |  |  |

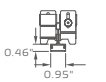

Clear Lens

| |
|---|
|  |
| 15/16\" |
| Dimension |
|  |
| Length & Wattage |
| 2' 10W 4' 20W |
| Efficacy |
| 650 LM/FT |
| Custom Pattern |
| Yes |
| Beam Angle |
| 70°, 90° |
|  |

Micro Reflector

| |
|---|
|  |
| 15/16\" |
| Dimension |
|  |
| Length & Wattage |
| 2' 10W 4' 20W |
| Efficacy |
| 525 LM/FT |
| Custom Pattern |
| / |
| Beam Angle |
| 85° |
|  |

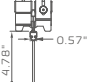
Signage

| |
|---|
|  |
| 9/16\" |
| Dimension |
|  |
| Length & Wattage |
| 2' 10W 4' 20W |
| Efficacy |
| 650 LM/FT |
| Custom Pattern |
| / |
| Beam Angle |
| 128° |
|  |

LED

Color Temp: 3000K,3500K,4000K,5000K
CRI: >80
Lifetime: >50,000H L70 minimum

Driver

Input Voltage: 100-277VAC
Dimming: 1-10V
Driver: Each remote driver for 3pcs units

General

Finish: Anodised Silver
Materials: Anodised Aluminium
Listings: US Patent, UL, DLC, Damp Rated, IC Rated, CCEA
Mounting: Recessed
Warranty: 5 Years Limited

Function Options

24V DC Options
Emergency Option
CCEA Option
Custom Cable Length
Plenum Rated Cable Option



US PATENT
10125934





Rethink Linear Luminaires



1.3" Zeta Slim

Functionality and precise performance are bended perfectly in Zeta Slim, it is destined to become a longstanding classic in our architectural linear collection. As we strive to stand out of the competition, the Zeta is complete.

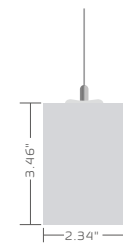

2.3" Zeta Bold

The big brother of the ZE (S), this new addition to the Zeta family presents a highly elegant, bold 2.3" rectangle form that stuns any modern applications.

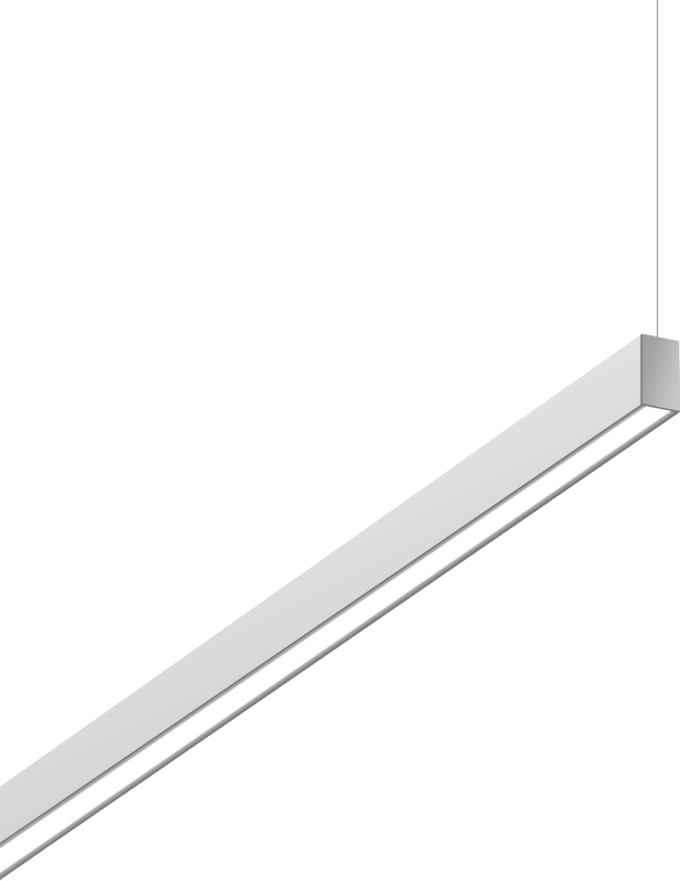

Blending Precise Performance With Elegant Design

Exquisite

Zeta series is a unique linear series that brings any space to the center stage. These timeless, streamlined forms blend well with contemporary decors and modern workplaces. These linear luminaries simply provide wide, powerful lighting to any atmosphere.

Up to 8' Length

It is available in 2', 4' and 8'. Various lengths to meet your different needs for any application and create linear lighting atmosphere.



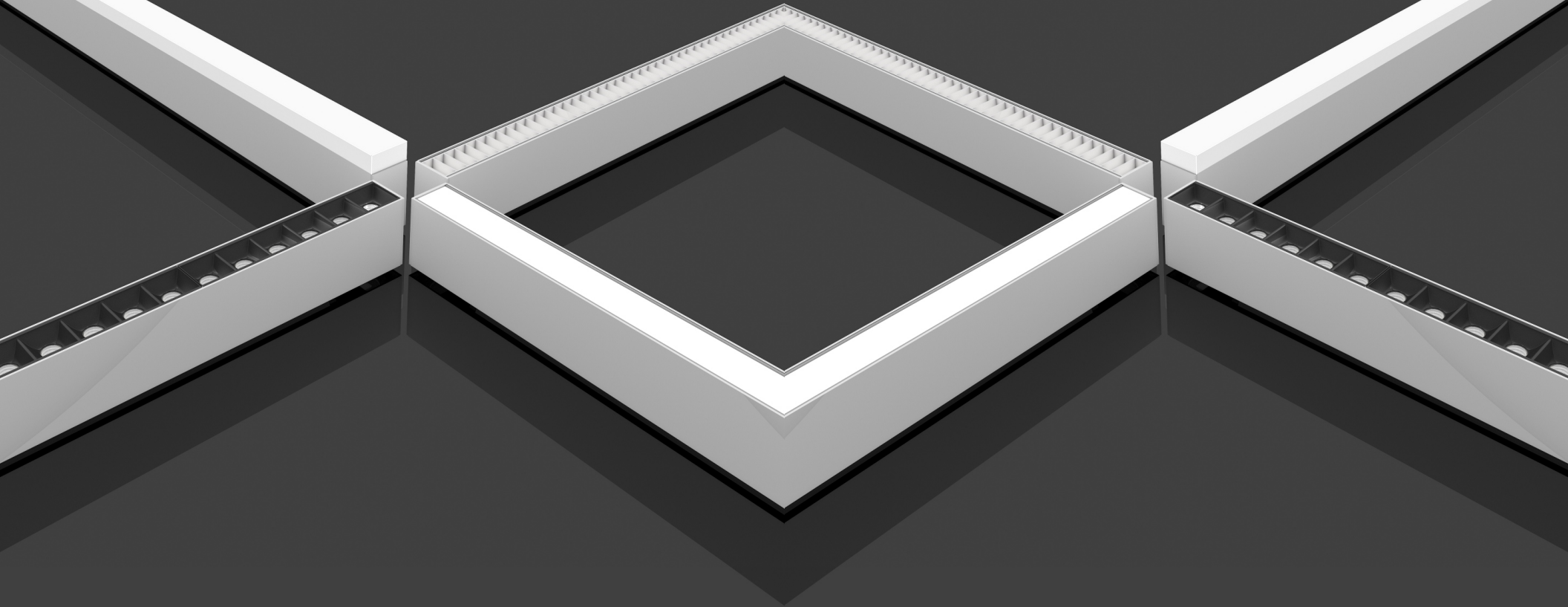

Lens Challenges

Each of these professional lenses challenges the highest glare rating. We are elevating our entire architectural product line to a higher standard.



Diffuser

It allows the light to custom the diffuser lengths, up to 42'.

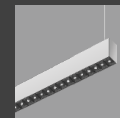

Micro Reflector

Exclusive low glare modular optics, UGR<15.

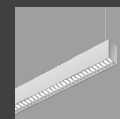

Louver

Straight blade louver, allows the light to diffuse for a direct and indirect lighting combination.

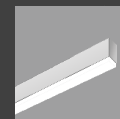

Convex

Unique design with acrylic lens

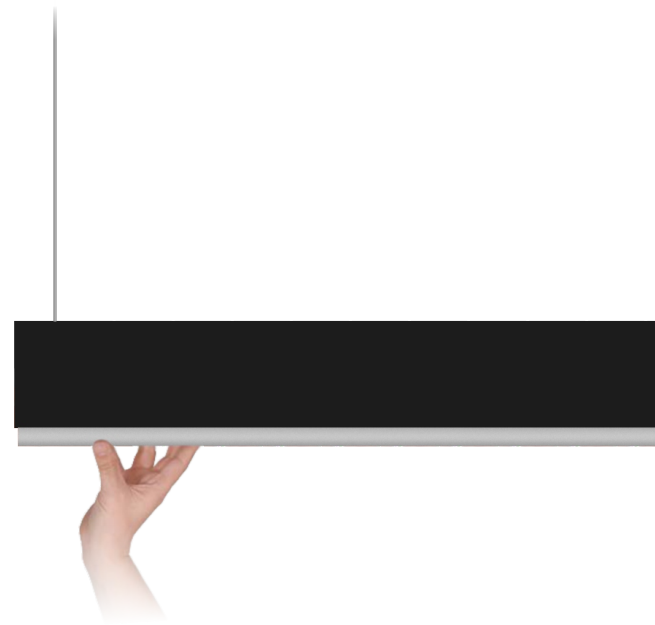
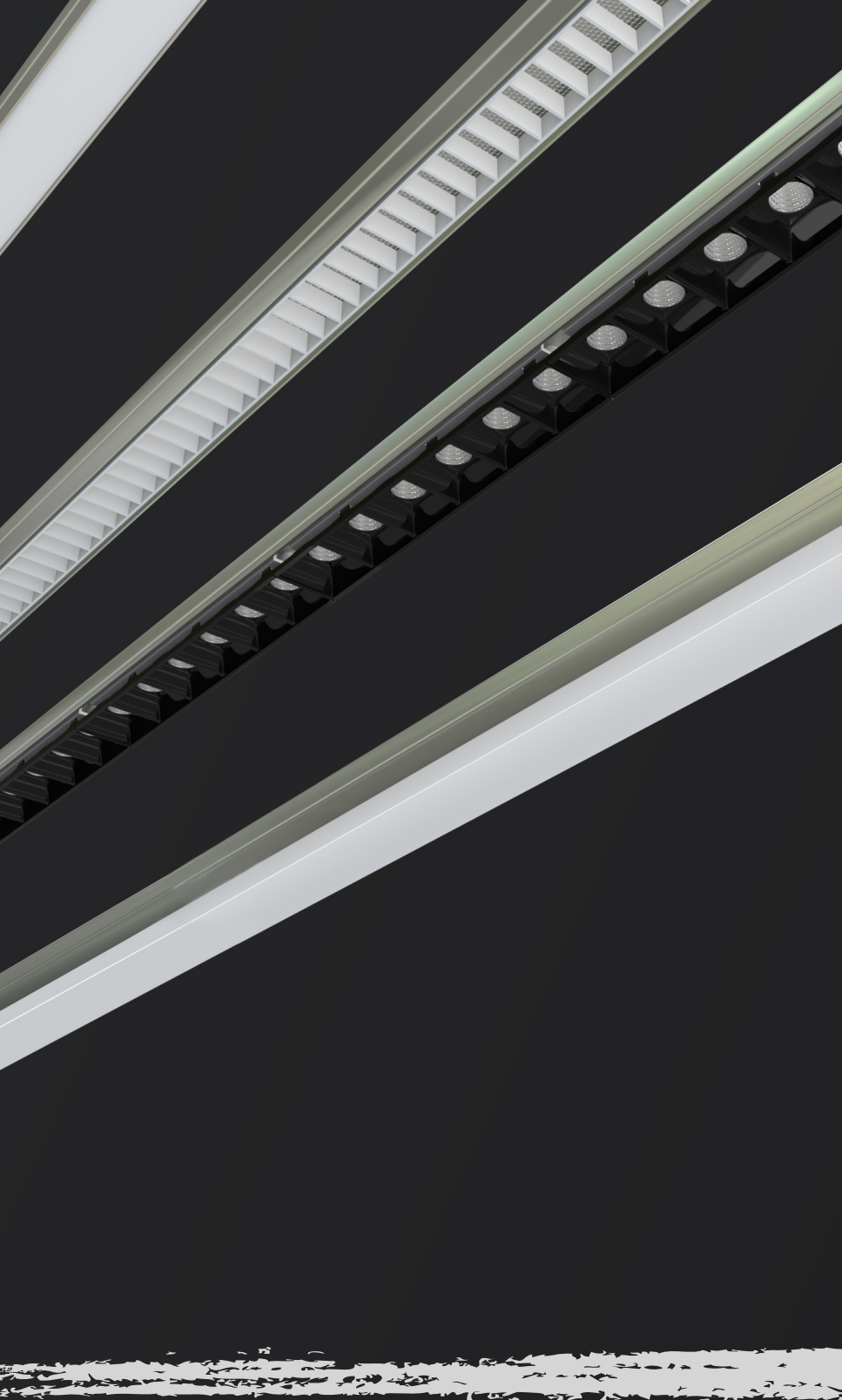

Functional Style

Built on the core of its modern, practical design philosophy, the Zeta series allow easy access to critical components to simplify installation or in the event that repair or replacement of different CCT becomes necessary.



Multiple Lighting Distributions

When suspended, the Zeta Series can provide smooth uplight and downlight, allowing for wider spacing between fixtures and better ceiling light uniformity.

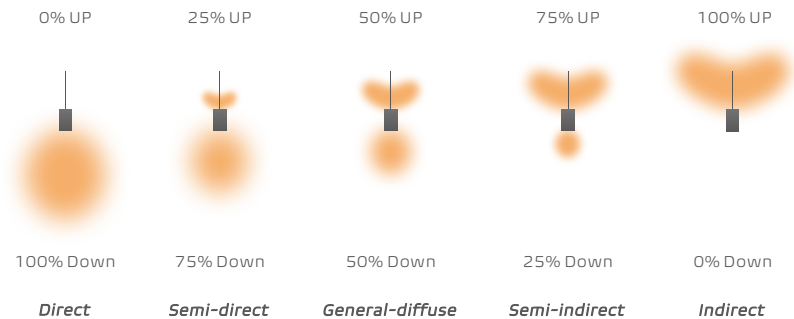

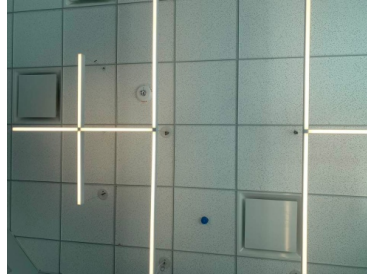

The Art of Design Flexibility

Simple Tools to Configure Unique Shape

Unleash lighting design flexibility with Zeta with different shapes and patterns, it adds fun factor into each room. These creations will let you suggest rhythm, communicate meaning and showcase element of life.

Seamless Integration Continuous Roll-Out Lens

Create clean, seamless runs that are quicker to install with this quality press-in diffuser lens that will not crinkle or bow. It is available in lengths of up to 42'.





Versatile Mountings

This linear luminaire can be pendant, surface or wall mount. It is strategically placed throughout the space to create pleasing illumination in rows or individual placement, providing the flexibility to adapt to the changing needs of the space or environment. Customer applications include open and traditional offices, classrooms, corridors, retail or anywhere stylish lines of light are desired.

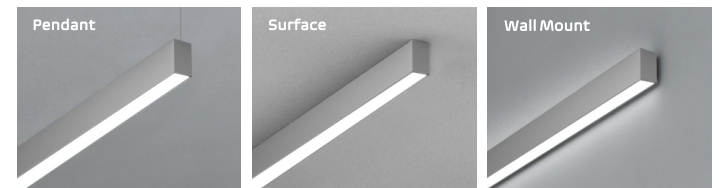

Zeta Slim 1.3"

Diffuser



Length & Wattage

2' 20W
4' 40W
8' 80W

Efficacy *

1050lm/ft

Beam Angle



Up 150°, Down 100°

Micro Reflector



Length & Wattage

2' 20W
4' 40W
8' 80W

Efficacy *

1200lm/ft

Beam Angle



Up 150°, Down 48°

Louver



Length & Wattage

2' 20W
4' 40W
8' 80W

Efficacy *

750lm/ft

Beam Angle



Up 150°, Down 60°

Convex



Length & Wattage

2' 20W
4' 40W
8' 80W

Efficacy *

1100lm/ft

Beam Angle



Up 150°, Down 110°

*Base on up & down light distribution with 3500k

LED

Color Temp: 3000K, 3500K, 4000K

CRI: 80+ or 90+ Optional

Lifetime: >50,000H L70 minimum

Driver

Internal Driver: 100-277V AC

External Driver: 110-347V AC

Direct And Indirect Lighting Distribution Adjustable
Wattage Adjustable (100%, 75%, 50%)

Dimming: 1-10V

Tested Dimmers: Lutron® Diva-Dvtv, Leviton® IP-710-DL

General

Finish: White or Custom

Materials: Anodised Aluminium

Listings: UL, Damp Rated

Warranty: 5 Years Limited

Mounting

Custom Pattern

Pendant, Surface, Wall Mount Available

Function Options

Emergency Option

Sensor Option



Joiners

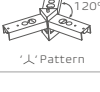
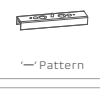
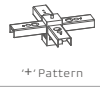
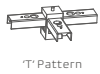

Canopy Style



1.6 in. round



1.6 in. square



4.5 in. round



4.5 in. square



4.5 in. round
w/ EM



4.5 in. square
w/ EM

T-Grid Hangers For Drop Ceiling



T-Grid Hanger (Feed)



T-Grid Hanger (Non-Feed)

Dimensions

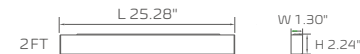

Zeta Bold 2.3"

Diffuser

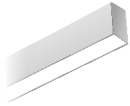

Length & Wattage

2' 20W
4' 40W
8' 80W

Efficacy *

1050lm/ft

Beam Angle



Up150°,Down 100°

Micro Reflector



Length & Wattage

2' 20W
4' 40W
8' 80W

Efficacy *

950lm/ft

Beam Angle



Up150°,Down 60°

Louver

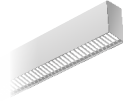

Length & Wattage

2' 20W
4' 40W
8' 80W

Efficacy *

900lm/ft

Beam Angle



Up150°,Down 80°

Deep Regressed

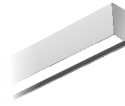

Length & Wattage

2' 20W
4' 40W
8' 80W

Efficacy *

950lm/ft

Beam Angle



Up150°,Down 75°

*Base on up & down light distribution with 3500k

LED

Color Temp: 3000K, 3500K, 4000K

CRI: 80+ or 90+ Optional

Lifetime: >50,000H L70 minimum

Driver

Internal Driver: 100-277V AC or 110-347V AC

Direct And Indirect Lighting Distribution Adjustable

Wattage Adjustable (100%, 75%, 50%)

Dimming: 1-10V

Tested Dimmers: Lutron® Diva-Dvtv, Leviton® IP-710-DL

General

Finish: White or Custom

Materials: Anodised Aluminium

Listings: UL, Damp Rated

Warranty: 5 Years Limited

Mounting

Custom Pattern

Pendant, Surface, Wall Mount And Recessed Available

Function Options

Emergency Option

Sensor Option



Joiners

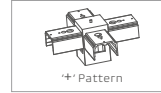

Canopy Style

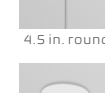
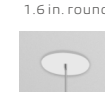

T-Grid Hangers For Drop Ceiling

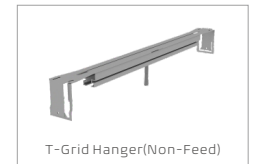
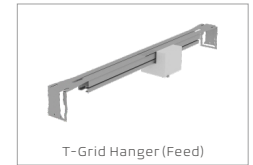

Dimensions

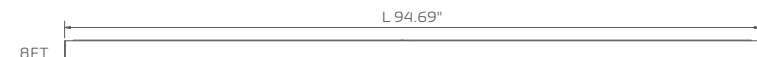
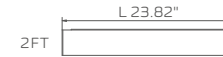

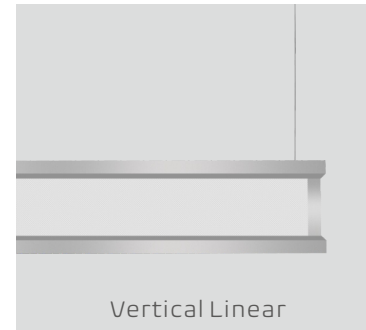

Vertical Linear



Up/Down Linear

Pendant Linear LED Luminaire

The direct / indirect pendant linear luminaires are integrated with ultra-thin semi-transparent optics, making a nearly transparent luminaire when off and excellent uniformity and efficiency when on, precisely controlled optimal direct and indirect distributions.

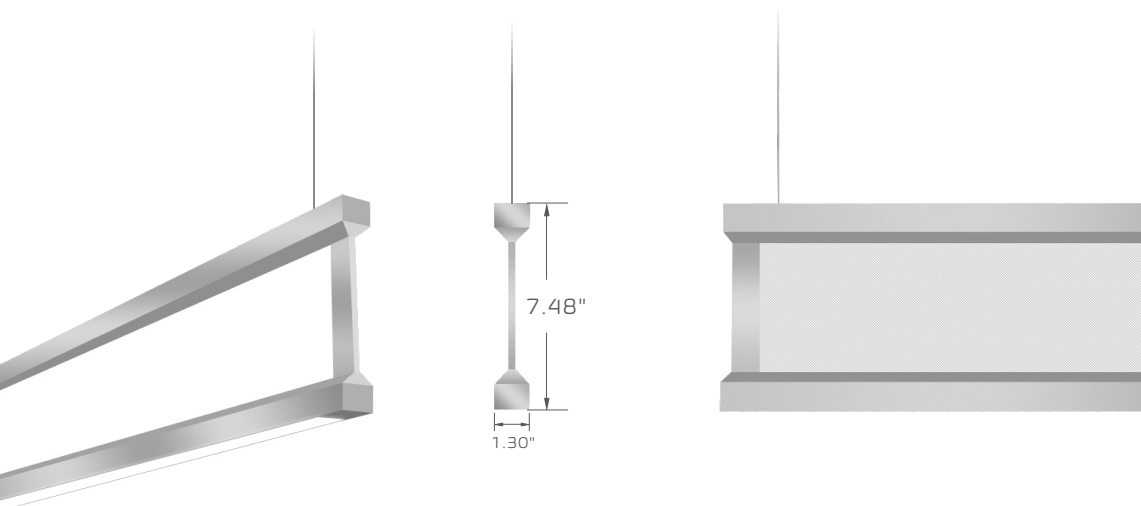

A Choice of Design Aesthetic

Unique Design

Transparent, vertical optics designed specifically for LED sources are integrated with minimalist design and architectural materials to create a broad range of solutions.

Advanced Optics

The ultra-thin semi-transparent optics highly transmits the flux of LEDs and evenly delivers the lights at the horizontal sides. It is utilizing an advanced LED optical system to achieve superior performance.

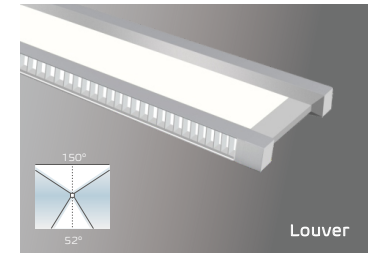
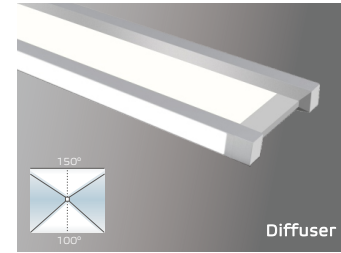

Visual Comfort

We strive to challenge the highest visual comfort standard by offering multiple professional lenses, distributions and CCT options.

Powerful

When suspended, the LV Series can provide smooth direct or indirect distribution, allowing for wider spacing between fixtures and better ceiling light uniformity.



Direct+

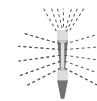

Indirect

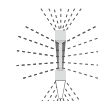

General Diffuse
Ext. Driver Only*

The Magic Of CCT Adjustable

- Let you choose up to different 8 color temperatures*
- Dual Circuits output, adjust CCT with 0-10V dimming system *

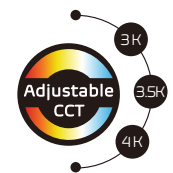



Transparent Optics

Advanced Optics

The unique design makes it semi-transparent luminaire when off, excellent uniformity and efficiency when on.

Delicate Laser Dot

The ultra-thin semi-transparent optical light guide plate highly transmits the flux of LEDs and evenly delivers the lights at the horizontal sides.



Simplicity Meets Performances

Each power feed connections up to 40ft,
Continuous linear integrates this product family

This engineered luminaire joining design allows for simple and intuitive assembly in the field easily. It is junction plate acted as connector and ensure that luminaire rows snap into a laser straight line.

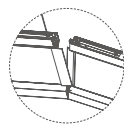

Slide fixtures together

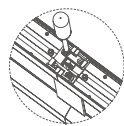

Secure fixtures together



Diffuser



| Internal Driver | External Driver |
|------------------------------|------------------------------|
| Length 4' | Length 4' |
| Wattage 40W | Wattage 45W |
| Efficacy 1000lm/ft | Efficacy 1125lm/ft |
| Input Voltage 100-277V AC | Input Voltage 110-347V AC |
| Beam Angle | Beam Angle |



Up150°,Down 100°



Up150°,Down 100°

Louver



| Internal Driver | External Driver |
|------------------------------|------------------------------|
| Length 4' | Length 4' |
| Wattage 40W | Wattage 45W |
| Efficacy 800lm/ft | Efficacy 900lm/ft |
| Input Voltage 100-277V AC | Input Voltage 110-347V AC |
| Beam Angle | Beam Angle |



Up150°,Down 52°



Up150°,Down 52°

Canopy Style

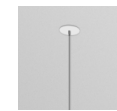

1.6 in. round



1.6 in. square

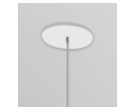

4.5 in. round



4.5 in. square

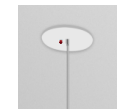

4.5 in. round
w/ EM



4.5 in. square
w/ EM

LED

Color Temp: 3000K, 3500K, 4000K, 5000K or CCT Adjustable

CRI: 80+ or 90+ Optional

Lifetime: >50,000H L70 minimum

Driver

Type: Internal Or External Optional

Dimming: 1-10V

Tested Dimmers: Lutron® Diva-Dvtv, Leviton® IP-710-DL

General

Materials: Anodised Aluminium

Listings: UL, FCC, LM79, LM80

Warranty: 5 Years Limited

Mounting

Mounting: Pendant

Ceiling Type: Dry Ceiling Or Drop Ceiling

Continuous Runs

Function Options

Emergency Option

Sensor Option

T-Grid Hangers For Drop Ceiling

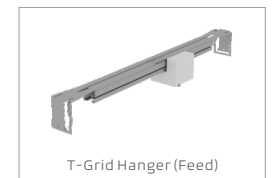

T-Grid Hanger (Feed)



T-Grid Hanger (Non-Feed)



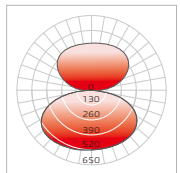
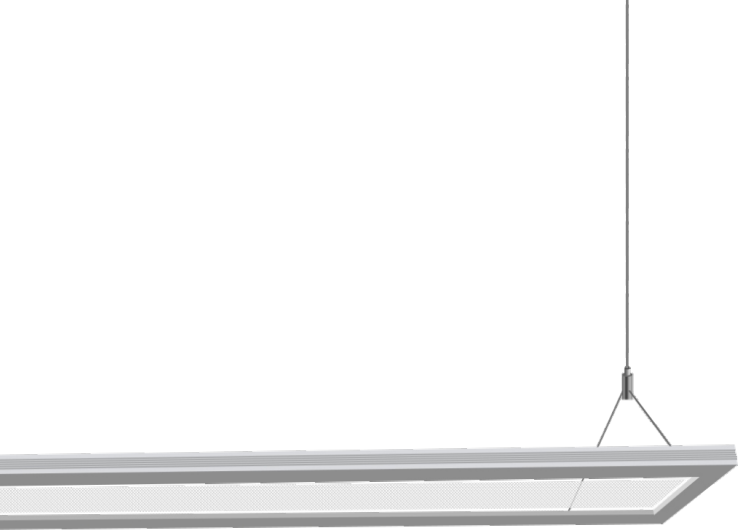

AVERAGE BEAM ANGLE(50%): 360°

Up/Down Linear

Suspended from the ceiling, this strikingly beautiful luminaire combines brilliant aesthetics with space-filling light.

Transparent Optics
45% uplight and 55% downlight. And when it's switched off, clear lens means there's no visible light source.

Premium Quality
All contained within a premium quality aluminium. High precision light guide made of PMMA materials.

Easy To Maintain
All drivers are built-in, and can be replaced easily, which are more convenient to fix and maintain.



All drivers are built-in, and can be replaced easily, which is more convenient to fix and maintain.

Dip switch for CCT adjustable

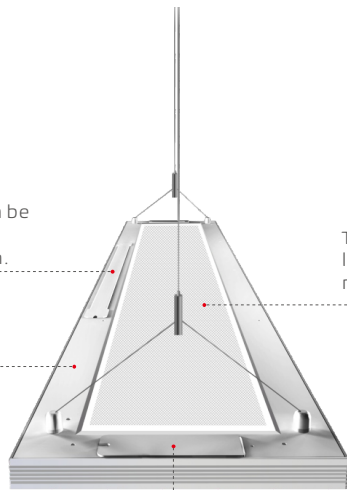

The transparent PMMA light guides harness the raw flux of LEDs

Seamless Continuous Runs

Designed for All Projects

CCT Select - Puts flexibility at your fingertips

This linear's sturdy construction is paired with the ability to deliver light that provides both quality illumination and energy-efficient performance. Incorporating top quality lighting components, it is truly a modern luminaire that provides flexibility in how a space is illuminated, featuring independently-selectable color temperatures by using dip switches, you can choose several color temperatures, creating your optimal lighting experience.





Seamless Continuous Runs

Create Linear Lighting Atmosphere

Seamless

It's highly engineered luminaire joining design allows for simple and intuitive assembly in the field without tools. Its junction plate ensures that luminaire rows snap into a laser straight line.

Continuous Runs

One power can feed multiple lamps to minimize installation time and save labor cost. Runs of luminaires that are up to 80ft in length are designated. This means that the run is comprised of a combination 4ft and/or 8ft sections to be assembled on site using our joining system.

| Model | Max Connecting QTY in 120VAC | Max Connecting QTY in 230VAC | Max Connecting QTY in 277VAC |
|-------------------|---------------------------------|---------------------------------|---------------------------------|
| DP4 - 4FT 40Watts | 9 PCS | 18 PCS | 20 PCS |
| DP8 - 8FT 80Watts | 4 PCS | 8 PCS | 10 PCS |



DP4-DM-XXX

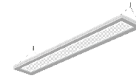

| |
|--------------------------------------|
| Length |
| 4' |
| Wattage |
| 40W |
| Efficacy |
| 1150LM/FT |
| CCT Adjustable |
| 3000K, 3500K and 4000K by dip switch |

DP8-DM-XXX



| |
|-----------------------|
| Length |
| 8' |
| Wattage |
| 80W |
| Efficacy |
| 1150LM/FT |
| CCT Adjustable |
| N/A |

LED

| |
|--|
| Color Temp: 3000K, 3500K, 4000K, 5000K or CCT Adjustable |
| CRI: 80+ or 90+ Optional |
| Lifetime: >50,000H L70 minimum |

Driver

| |
|---|
| Internal & Replaceable Driver |
| Input Voltage: 100-277V AC or 110-347V AC optional |
| 1-10V Dimming |
| Tested Dimmers: Lutron® Diva-Dvtv, Leviton® 1P-710-DL |

General

| |
|--|
| Finish: Alpine white |
| Materials: Anodised Aluminium |
| Listings: UL, FCC, DLC, CE, LM79, LM80 |
| Warranty: 5 Years Limited |

Mounting

| |
|---|
| Mounting: Pendant |
| Ceiling Type: Dry Ceiling Or Drop Ceiling |

Function Options

| |
|------------------|
| Emergency Option |
| Sensor Option |



Canopy Style



1.6 in. round



1.6 in. square

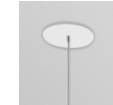

4.5 in. round



4.5 in. square

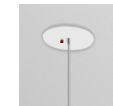

4.5 in. round w/ EM



4.5 in. square w/ EM

T-Grid Hangers For Drop Ceiling

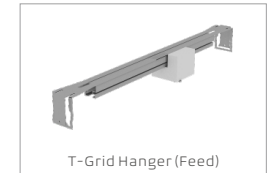

T-Grid Hanger (Feed)

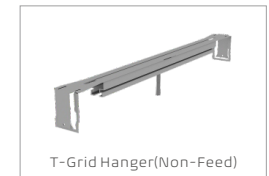

T-Grid Hanger (Non-Feed)